

Section 7

Table of Contents

7	ROADWAYS	1
7.1	General Requirements	1
7.1	Other Reference Documents.....	1
7.2	Industry Standards and Specifications.....	1
7.3	Other Applicable Acts and Legislations	1
7.4	Road Classifications.....	2
7.5	Roadway Cross-sections	3
7.5.1	Bike Lanes	3
7.6	Geometric Design Elements.....	3
7.7	Intersections	4
7.8	Cul-de-Sacs	5
7.9	Temporary Roads	5
7.10	Emergency Access	5
7.11	Pavement Design	5
7.11.1	General Requirements	5
7.11.2	Alternative Materials	6
7.12	Concrete Curb	6
7.13	Subdrains	6
7.14	Driveways	7
7.14.1	General Requirements	7
7.14.2	Driveway Materials	7
7.15	Curb Depression	8
7.16	Sidewalks	8
7.16.1	Tactile Surface Warning Plates.....	8
7.17	Location of Utilities.....	9
7.18	Parking	9
7.18.1	Accessibility Parking.....	9
7.19	Topsoil, Seed and Sod.....	9
7.20	Fences and Walls	9
7.20.1	Fences	9
7.20.2	Noise Attenuation Walls.....	10
7.21	Subdivision Entrance Structures	10

List of Tables

Table 1. Street Classifications - Residential

Table 2. Geometric Design Elements

Table 3. Curb Return Radii

Table 4. Minimum Pavement Design Requirements

Table 5. Driveway Requirements

Table 6. Concrete Sidewalk Parameters

7 ROADWAYS

7.1 General Requirements

This section outlines the recommended minimum requirements for the design and implementation of the transportation network and roadways within the Town of Tillsonburg. This section will outline the design requirements.

7.1 Other Reference Documents

All roads and transportation systems are to be designed and constructed in accordance with the latest version of this manual as well as other industry standards and best practices, including but not limited:

- Oxford County Official Plan
- Town of Tillsonburg Standard Drawings
- Ontario Provincial Standard Specifications (OPSS) and Ontario Provincial Standard Drawings (OPSD) prepared by the Ministry of Transportation (MTO)
- Geometric Design Guide for Canadian Roads prepared by the Transportation Association of Canada (TAC)
- Ontario Traffic Manual (OTM) prepared by the Ministry of Transportation (MTO)
- Roadway Lighting ANSI/IES RP-8 prepared by the Illuminating Engineering Society of North America (IESNA), latest edition
- O. Reg. 366/18: Minimum Maintenance Standards for Municipal Highways

7.2 Industry Standards and Specifications

All roads and transportation systems are to comply with the latest version of all applicable industry standards and specifications for quality management and quality control, including but not limited to the following:

- Electrical Safety Authority (ESA)
- Canadian Standards Association (CSA)
- American Society for Testing and Materials (ASTM)

7.3 Other Applicable Acts and Legislations

This manual does not supersede, nor replace any legislation governing the design and construction of roads and transportation systems. When carrying out design and construction of

Town linear projects, the Proponent is to be fully familiar with the latest version of the following legislative requirements:

- Ontario Highway Traffic Act
- Municipal Act
- Environmental Assessment Act
- Environmental Protection Act
- Accessibility for Ontarians with Disability Act (AODA)

7.4 Road Classifications

All urban roadways shall be classified according to the traffic volume expected and the intended use of the roadway. The proposed classification of all streets in the development shall be confirmed with the Town prior to commencement of design.

All roads within the urban boundary shall be designed and constructed to Town standards with full municipal services.

Table 1 is presented as a summary of the three major road classifications within the Town. However final classification will ultimately be determined by and at the sole discretion of the Town.

Table 1. Street Classifications - Residential

	Local	Collector	Arterial
Surfaced Width (m)	8.0	10.0	14.0
Right of Way (R.O.W) (m)	20.0	22.0	26.0
Number of Through Lanes per Direction	1	1	2
Traffic Volume Range (AADT)	Less than 2,000	2,000 to 4,000	Greater than 4,000
Posted Speed Range (km/h)	40-50	50	50 - 60 ¹
Minimum Design Speed (km/h)	60	70	80
Utility Location	As per the Town of Tillsonburg Typical Cross Sections		

1. *Proponent to confirm with the Town and County prior to Design.*
2. *School / community safety zone 40*
3. **CONFIRM SPEED**

7.5 Roadway Cross-sections

Refer to the typical cross-sections illustrated in Appendix “A” Town of Tillsonburg Standard Drawings, within these guidelines for requirements on above and below grade infrastructure for local, collector, and arterial roads.

Typical cross-sections are included in Appendix “A” of manual for the following:

- Local Roads
- Collector Roads
- Arterial Roads

The cross-sections are provided for guidance purposes during design and construction.

Deviations may be necessary and will be reviewed and accepted by the Town on a case-by-case basis.

The Proponent shall provide justification for the change for review at the full discretion of the Town. 18.0m R.O.W can be used in reconstructions pending Town approval. 18.0m R.O.W within new subdivisions are not permitted unless received Town approval such as “window lanes”.

7.5.1 Bike Lanes

Bike lanes shall be incorporated into typical road cross-sections at the request of the Town. Bike Lanes shall be a minimum of 1.5m in width and shall clearly be delineated with pavement markings from the vehicle travel lane on collector and arterial roads.

7.6 Geometric Design Elements

Geometric design for horizontal and vertical road alignment must meet the following requirements or the TAC Geometric Design Guide for Canadian Roads Part 1 and Part 2, whichever is more conservative.

All points of grade change in excess of 1.0% shall be designed with vertical curves as outlined in the TAC Guide and shall list the vertical curve properties on the plan and profile drawings.

Table 2. Geometric Design Elements

Geometric Detail	Local	Collector	Arterial
Maximum Longitudinal Road Grade (%)	8.0	8.0	6.0
Minimum Longitudinal Road Grade (%)	0.5	0.5	0.5
Minimum Crossfall (%)	2.0	2.0	2.0

Geometric Detail	Local	Collector	Arterial
Sidewalk Separation from Back of Curb (m)	2.2	2.2	2.2
Maximum Sub Base Grade (%)	3.0	3.0	3.0
Maximum Grade Major Approach at Intersection (%)	2.0	2.0	3.0
Grade for Minor Approach at Intersections (%)	Match cross fall of major approach		
Minimum Curb Grade (%)	0.5	0.5	0.5
Vertical Curve Minimum Sight Stopping Distance (m)	85.0	85.0	85.0 – 140.0
Maximum Superelevation (%)	2.0	2.0	2.0

7.7 Intersections

All standards pertaining to the design of intersections are as outlined in Table 2 and shall be in accordance with TAC Geometric Design Guide for Canadian Roads, latest edition.

Should there be an island within the intersection, the Proponent must have a suitable separation and radius to allow for a Tandem Axle Plough complete with wing with a 0.5m buffer.

At a minimum, curb return radii measured from edge of pavement and the daylighting (sight triangle) requirements from property line shall meet the following as outlined in Table 3.

Table 3. Curb Return Radii

Street to Street	Minimum Curb Return Radii	Daylighting
Local to Local	7.5m R	3m x 3m
Local to Collector	9.0m R	5m x 7m
Local to Arterial	9.0m R	5m x 10m
Collector to Collector	12.0m R	7m x 7m
Collector to Arterial	12.0m R	7m x 10m
Arterial to Arterial	15.0m R	10m x 10m
Industrial to any other street	18.0m R	12m x 12m

7.8 Cul-de-Sacs

Where necessary and approved by the Town, temporary and permanent cul-de-sacs are to be implemented in accordance with this manual.

The minimum radii of the cul-de-sac as measured from the edge of pavement shall be 15m. The minimum road allowance radii of the cul-de-sac is to be 20m as per the Town standard drawings.

Minimum gutter grades of 0.8% are to be maintained along the flow line of all gutters around the cul-de-sacs, the design road grade on the cul-de-sac and at the beginning of the bulb area where catchbasins are to be located.

The details shall show gutter, crown and other grades sufficient to determine that the road will properly drain.

7.9 Temporary Roads

Temporary roads shall be constructed with smooth transitions to paved structures. Pavement design for temporary roads are to be confirmed by a qualified Geotechnical Engineer and have a minimum of 450mm Granular 'B' and 150mm Granular 'A'.

7.10 Emergency Access

Emergency access shall be designed in consultation with emergency services and the Town. The use of knock over bollards and gates shall be evaluated on a case by case basis.

7.11 Pavement Design

7.11.1 General Requirements

Minimum thickness of asphalt and granular materials are provided in Table 4. These designs are considered to be minimums and final thickness are to be recommended and confirmed by a qualified Geotechnical Engineer.

All designs are to be submitted to the Town for approval and shall comply with the current OPSS standards.

Table 4. Minimum Pavement Design Requirements

Road Classification	Surface Course HL3 (mm)	Base Course HL8 (mm)	Granular 'A' (mm)	Granular 'B' (mm)	Total (mm)
Local	40	50	150	300	540
Collector	40	60	150	375	625
Arterial	50	60	150	450	710

Road Classification	Surface Course HL3 (mm)	Base Course HL8 (mm)	Granular 'A' (mm)	Granular 'B' (mm)	Total (mm)
Industrial	50 (HL4)	60	150	450	710

7.11.2 Alternative Materials

The Town may consider alternative materials on a case-by-case basis, such as reclaimed concrete and asphalt for typical granular applications such as:

- Engineered fill
- Pavement shoulders
- Construction access roads, bike paths and trails,

A qualified Geotechnical Engineer shall outline the suitability and location of reuse of reclaimed materials and shall be submitted for approval to the Town. The materials shall be in accordance with OPSS.

7.12 Concrete Curb

Curb and gutters shall be in accordance with OPSS 353 and OPSD 600.10, 600.04 and 600.09.

The minimum curb and gutter grade will be 0.5% unless it is located in cul-de-sacs where it will be 0.8%.

For all retrofit projects, concrete curb will be curb and gutter as per the Town's typical cross section for the road type in accordance with the applicable OPSD, or as otherwise approved by the Town.

7.13 Subdrains

Subdrains are to be in accordance with the applicable OPSS. Subdrains are to be installed a minimum of 3.0m from each catchbasin structure. Additional Subdrains may be required on a case-by-case basis as specified by a qualified Geotechnical Engineer and or the Town or where the majority of longitudinal grades are less than 1% in fine clay or silt conditions. Subdrains are to include the connection of an outlet to a drainage structure.

Subdrains shall be perforated high density polyethylene pipe complete with geotextile sock with a minimum diameter of 150mm and a minimum slope of 0.5% installed continuously below the curb and gutter complete with clear stone bedding wrapped in filter fabric, unless soil conditions warrant otherwise as recommended from a Geotechnical Engineer. Subdrains shall be installed in accordance with OPSD 216.021.

7.14 Driveways

7.14.1 General Requirements

Driveways and approaches/curb depressions are to be designed in accordance with OPSS, OPSD, Town of Tillsonburg Zoning By-law.

Minimum design grade for all driveways are 2% and maximum grade are 8.0%. The specified driveway grade shall be directed away from the lot towards the roadway. The use of reverse fall driveways is not permitted.

Existing driveway to property and driveway approaches are to be replaced with like materials if impacted by construction activities.

All new driveways and approaches within the Town's R.O.W. shall be submitted to the Town for review and approval prior to construction. The details shall include the location, width, slopes and grades.

Existing curb returns at driveways will be reinstated on a case-by-case basis as approved by the Town.

A minimum driveway separation distance shall be determined based on TAC standards, Town of Tillsonburg Zoning By-law (No.3295 as amended), and in accordance with OPSS.

7.14.2 Driveway Materials

Table 5 outlines material requirements for asphalt and concrete driveways. All driveways are to be in accordance with OPSS and this manual.

Driveway and driveway approaches shall match existing conditions wherever possible and applicable. Any deviation is to be reviewed and approved by the Town.

Table 5. Driveway Requirements

Land Use	Asphalt	Concrete
Single Family Residential	50mm of HL3 surface course 200mm of Granular 'A'	125mm Concrete 150mm Granular 'A'
Apartments, Commercial and Light Industrial Properties	40mm of HL3 surface course 50mm of HL4 base course 300mm of Granular 'A'	150mm Concrete 150mm Granular 'A'
Heavy Industrial Properties	50mm of HL4 surface course 60mm of HL8 base course 300mm of Granular 'A'	200mm Concrete 300mm Granular 'A'

7.15 Curb Depression

Curb depressions are required at all pedestrian road crossings and provide the smooth integration of vehicles to and from roadways at driveways. These are to be designed in accordance with Town of Tillsonburg Zoning By-law and the Accessibility for Ontarians with Disability Act (AODA).

7.16 Sidewalks

The location and extent of sidewalks shall be reviewed and approved by the Town and shall conform to typical Right of Way cross-sections as per the Town’s Standard Drawings wherever possible.

Sidewalk locations should first be located in areas to promote continuity of routes and provide direct access to major pedestrian destinations. It is the preference of the Town for the sidewalk to be located on the north and east side of the roadway in cases of only one sidewalk.

The Proponent shall take all precautions to minimize impacts to existing and propose driveways.

Reconstruction projects must have the sidewalk replaced or repaired if an existing sidewalk is in place. In the absence of an existing sidewalk, a new sidewalk is to be considered, at the discretion of the Town. Sidewalks shall be designed in accordance with Accessibility for Ontarians with Disabilities Act (AODA) requirements. Best attempts to eliminate depressing the sidewalk at driveways shall be taken,

Should sections of sidewalk be removed as part of development works, the minimum number of panels to be removed and replaced shall be three (3) on connecting streets to provide a smooth transition. Table 6 outlines typical concrete sidewalk design parameters.

Table 6. Concrete Sidewalk Parameters

Parameter	Requirement
Sidewalk Thickness	Residential – 125mm Street Crossings – 200mm Industrial/commercial entrances – 150mm
Sidewalk Width	1.5m (Local roads), 1.8m adjacent to curb as per OPSD 310.020
Sidewalk Grade *	0.5% to 8%
Sidewalk Crossfall	2% to 4%
Distance from Curb	Minimum 2.2m between back of curb and sidewalk

* Steeper grades shall be reviewed and approved by the Town based on site conditions.

7.16.1 Tactile Surface Warning Plates

As a minimum, tactile surface warning plates shall be integrated into sidewalks at curb ramps and depressed curb areas to assist pedestrians who are visually impaired. They shall be designed in

accordance with OPSD 0310 series, Accessibility for Ontarians with Disabilities Act (AODA) requirements and the Town of Tillsonburg Accessibility Plan, latest versions and as approved by the Town.

7.17 Location of Utilities

The location of all utilities within the road allowance are to be in accordance with the Typical Cross-section as per the Standard Drawings in this manual and Section 9 - Utilities of this document.

7.18 Parking

Parking is to be in accordance with the details in Town of Tillsonburg Traffic and Parking By-law.

7.18.1 Accessibility Parking

Where accessibility parking is warranted, the design and implementation shall be in accordance with the Accessibility for Ontarians with Disabilities Act (AODA) requirements and Town of Tillsonburg Traffic OTM Book 11, and Parking By-law, amended.

7.19 Topsoil, Seed and Sod

Topsoil shall be of the best quality fertile, loose, loamy material screened to be free from stones and weeds, to be placed and graded in the locations and to a minimum depth of 150mm as directed by the Town. Topsoil must not contain any chemical contamination or material detrimental to plant growth.

Bags are to bear the seed supplier's label clearly indicating species' content, grade and mass as well as the recommended seeding rate for the establishment of new lawn areas.

Sod shall be Commercial Grade Kentucky Bluegrass Nursery Sod according to the Specifications, Classifications and Use of Turfgrass Sod for Nursery Sod Growers Association of Ontario.

Sod shall be seeded and established in nursery sod fields as a turfgrass sod. There shall be no more than 5 broadleaf weeds per 40 square metres of sod and up to 20% non-specified grass. Sod shall be of sufficient density that no surface soil is visible.

Fertilizer shall be supplied in bags bearing the manufacturer's label indicating mass and analysis. All fertilizer shall be in granular form: dry, free flowing, free from lumps and with a composition of 8-32-16 (P-K-N) as per OPSS 803.

7.20 Fences and Walls

7.20.1 Fences

Fencing shall be implemented within the ROW as required by the Town. Fencing is not required where noise barrier walls are to be installed. Fencing within the ROW shall be a

minimum of 1.52m (5ft) and be non-climbable as required in the Town's Pool Enclosure By-Law.

If designed of chain link:

- (a) have a diagonal mesh length of not greater than 38mm and shall consist of 12-gauge galvanized steel wire; and
- (b) no rails, bracing or exposed attachments on the exterior that could facilitate or permit climbing from the exterior; and top and bottom rails are firmly fastened to upright posts, which rails consist of galvanized steel pipe at least 32 millimetres (1.25 inches) thick, provided that a continuous galvanized steel tension rod at least 5 millimetres (0.2 inches) thick may be substituted for the bottom rail. All private fencing shall be located entirely on private property and shall conform with standards outlined in the Town of Tillsonburg Fence By-Law and/or Pool Enclosure By-Law. Private gates shall not be allowed on fencing along the R.O.W.

7.20.2 Noise Attenuation Walls

The acoustical design and structure of all required noise attenuation walls shall be approved by the Town. A noise attenuation wall abutting Town property shall be located a minimum of 0.3m from the property line in the R.O.W.

All private noise attenuation walls shall be located entirely on private property and shall be designed by a Professional Engineer.

7.20.3 Subdivision Entrance Structures

The Town will not accept any subdivision gate or decorative entrance structures to be located on the R.O.W. If these entrances are required, the Proponent shall locate the structure entirely on private property. The Town will not be responsible for the future maintenance or repairs of any such subdivision entrance structures.

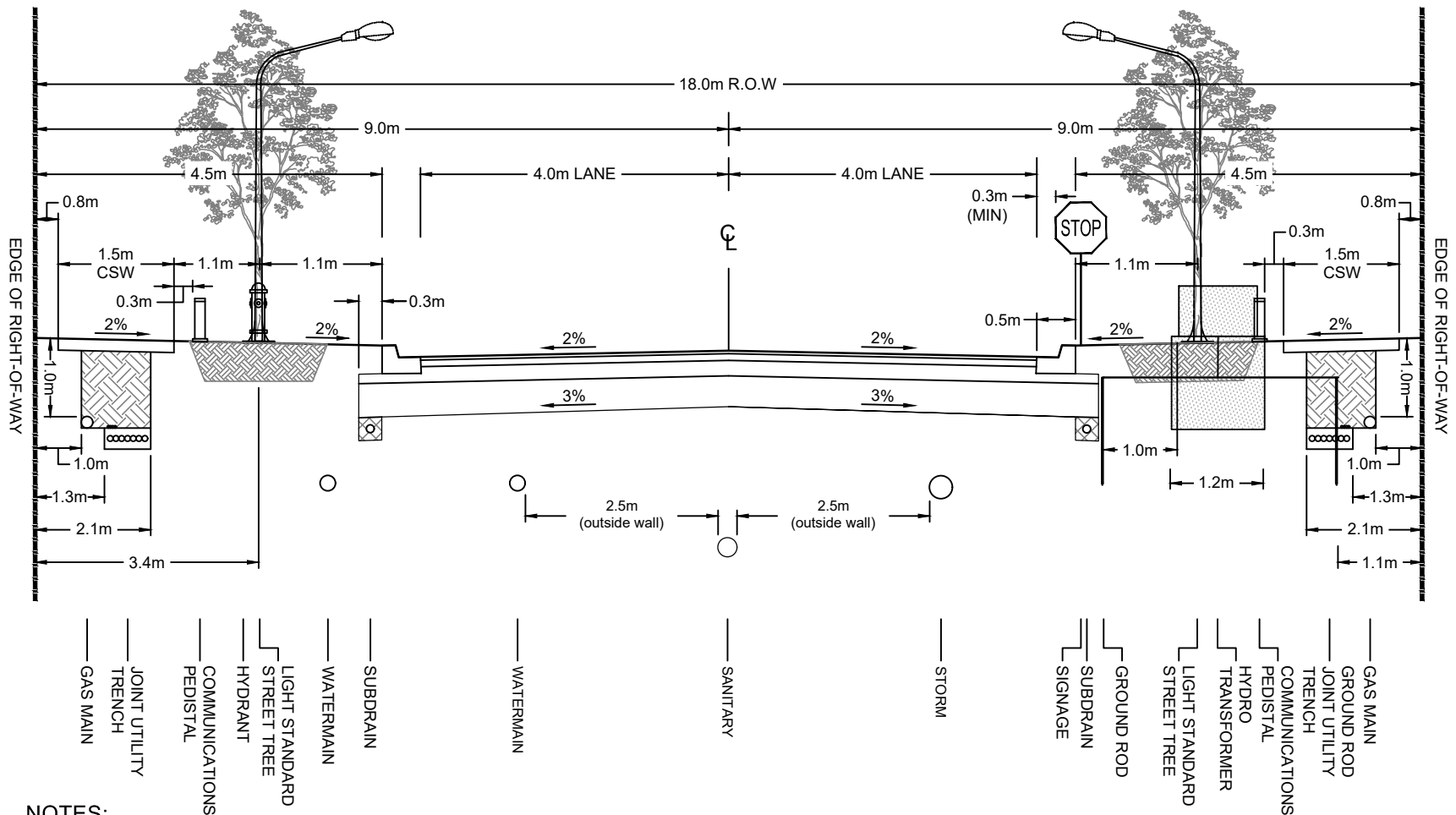

NOTES:

1. WATER DISTRIBUTION, WASTEWATER AND STORMWATER SYSTEMS TO BE DESIGNED IN ACCORDANCE WITH APPLICABLE TOWN OF TILLSONBURG DEVELOPMENT GUIDELINES & DESIGN CRITERIA, OXFORD COUNTY DESIGN GUIDELINES & SPECIFICATIONS, AND ONTARIO PROVINCIAL STANDARDS (OPSS/OPSD).
2. REFER TO SECTION 08 - STREET LIGHTING, TOWN OF TILLSONBURG DEVELOPMENT GUIDELINES & DESIGN CRITERIA AND ASSOCIATED TSD'S FOR LIGHT STANDARD AND POLE BASE LOCATION AND DEPTH.
3. REFER TO SECTION 07 - ROADS, TOWN OF TILLSONBURG DEVELOPMENT GUIDELINES & DESIGN CRITERIA FOR PAVEMENT DESIGN SPECIFICATIONS.
4. REFER TO SECTION 14 - PARKS AND STREETSCAPING, TOWN OF TILLSONBURG DEVELOPMENT GUIDELINES & DESIGN CRITERIA FOR STREET TREE SPECIFICATIONS. LOCATIONS WILL REQUIRE APPROVAL BY THE TOWN OF TILLSONBURG ENGINEERING DEPARTMENT.



STANDARD DETAIL

18.0m LOCAL ROAD
ALLOWANCE
8.0m ASPHALT

APPROVED

MANAGER OF ENGINEERING DATE
DIRECTOR OF OPERATIONS DATE

REVISION No. DATE: DEC 2021
SCALE: N.T.S.

TSD-700

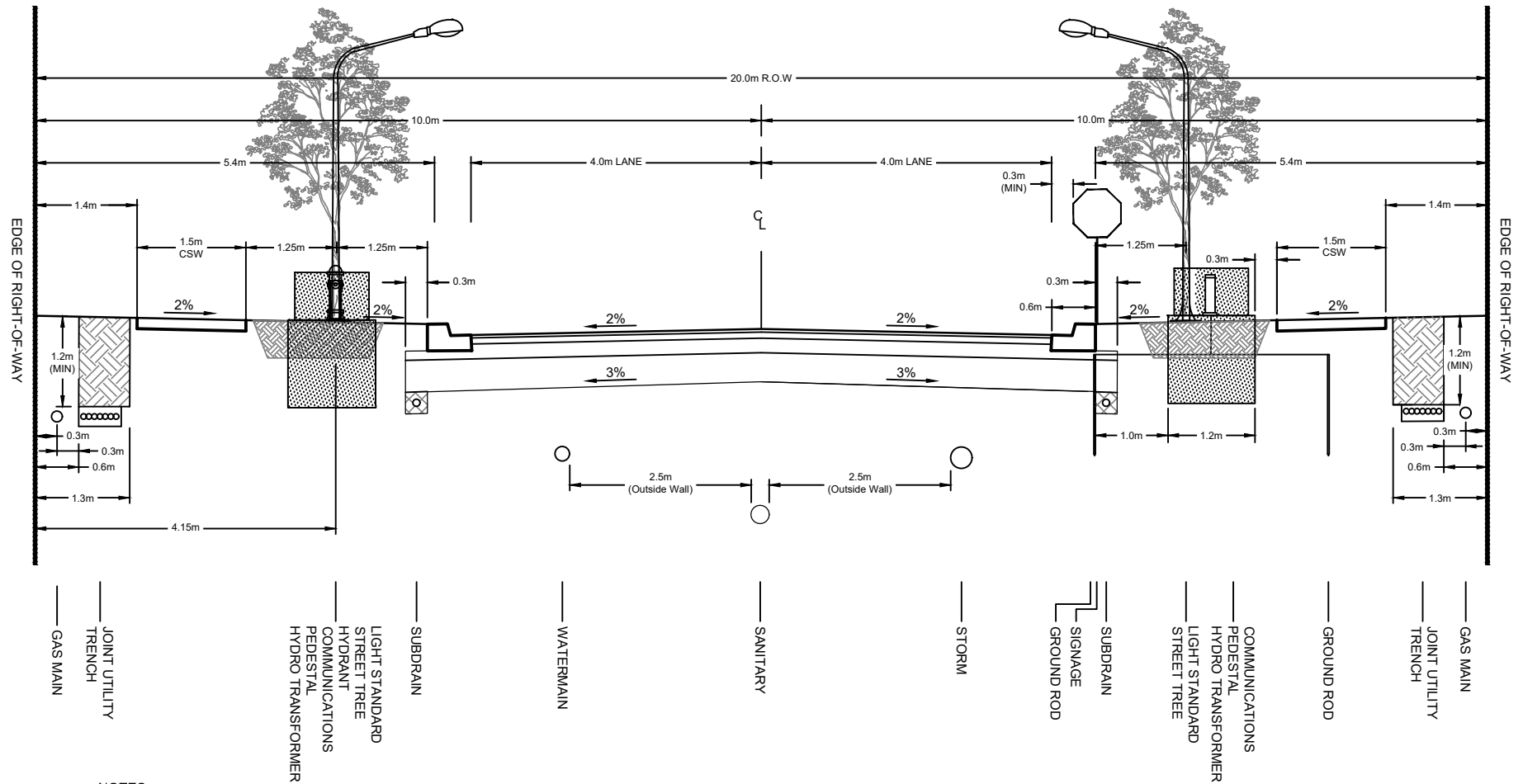

NOTES:

1. WATER DISTRIBUTION, WASTEWATER AND STORMWATER SYSTEMS TO BE DESIGNED IN ACCORDANCE WITH APPLICABLE TOWN OF TILLSONBURG DEVELOPMENT GUIDELINES & DESIGN CRITERIA, OXFORD COUNTY DESIGN GUIDELINES & SPECIFICATIONS, AND ONTARIO PROVINCIAL STANDARDS (OPSS/OPSD).
2. REFER TO SECTION 08 - STREET LIGHTING, TOWN OF TILLSONBURG DEVELOPMENT GUIDELINES & DESIGN CRITERIA AND ASSOCIATED TSD'S FOR LIGHT STANDARD AND POLE BASE LOCATION AND DEPTH.
3. REFER TO SECTION 07 - ROADS, TOWN OF TILLSONBURG DEVELOPMENT GUIDELINES & DESIGN CRITERIA FOR PAVEMENT DESIGN SPECIFICATIONS.
4. REFER TO SECTION 14 - PARKS AND STREETSCAPING, TOWN OF TILLSONBURG DEVELOPMENT GUIDELINES & DESIGN CRITERIA FOR STREET TREE SPECIFICATIONS. LOCATIONS WILL REQUIRE APPROVAL BY THE TOWN OF TILLSONBURG ENGINEERING DEPARTMENT.



STANDARD DETAIL

20.0m LOCAL ROAD ALLOWANCE 8.0m ASPHALT

APPROVED

..... DATE
MANAGER OF ENGINEERING
..... DATE
DIRECTOR OF OPERATIONS

REVISION No. DATE: AUGUST 2022

SCALE: 1:30

TSD-701

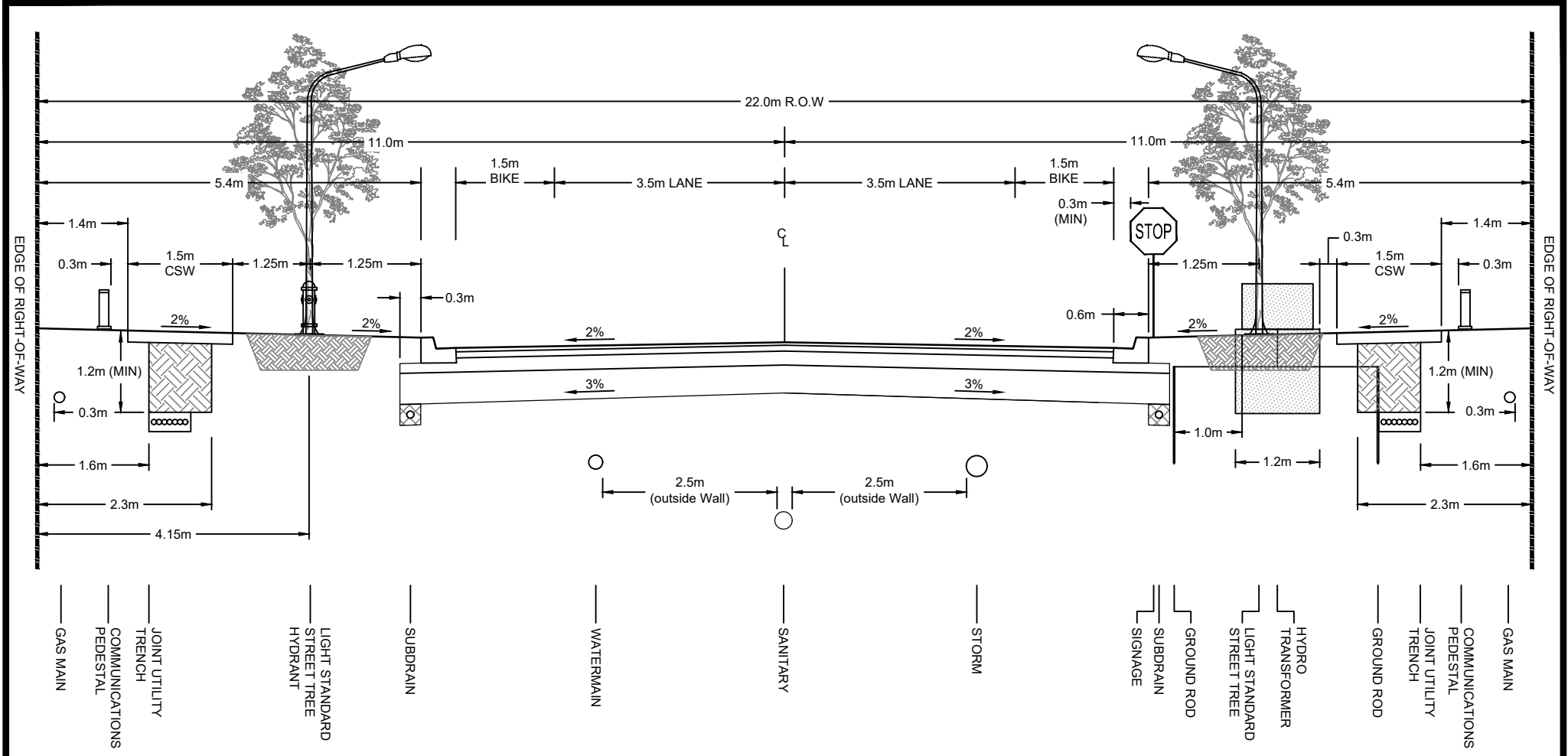

NOTES:

1. WATER DISTRIBUTION, WASTEWATER AND STORMWATER SYSTEMS TO BE DESIGNED IN ACCORDANCE WITH APPLICABLE TOWN OF TILLSONBURG DEVELOPMENT GUIDELINES & DESIGN CRITERIA, OXFORD COUNTY DESIGN GUIDELINES & SPECIFICATIONS, AND ONTARIO PROVINCIAL STANDARDS (OPSS/OPSD).
2. REFER TO SECTION 08 - STREET LIGHTING, TOWN OF TILLSONBURG DEVELOPMENT GUIDELINES & DESIGN CRITERIA AND ASSOCIATED TSD'S FOR LIGHT STANDARD AND POLE BASE LOCATION AND DEPTH.
3. REFER TO SECTION 07 - ROADS, TOWN OF TILLSONBURG DEVELOPMENT GUIDELINES & DESIGN CRITERIA FOR PAVEMENT DESIGN SPECIFICATIONS.
4. REFER TO SECTION 14 - PARKS AND STREETSCAPING, TOWN OF TILLSONBURG DEVELOPMENT GUIDELINES & DESIGN CRITERIA FOR STREET TREE SPECIFICATIONS. LOCATIONS WILL REQUIRE APPROVAL BY THE TOWN OF TILLSONBURG ENGINEERING DEPARTMENT.

STANDARD DETAIL

**22.0m COLLECTOR ROAD
ALLOWANCE (BIKE LANES)
10.0m ASPHALT**

APPROVED

MANAGER OF ENGINEERING DATE

DIRECTOR OF OPERATIONS DATE

REVISION No.	DATE: FEB 2022
	SCALE: N.T.S.
TSD-702	

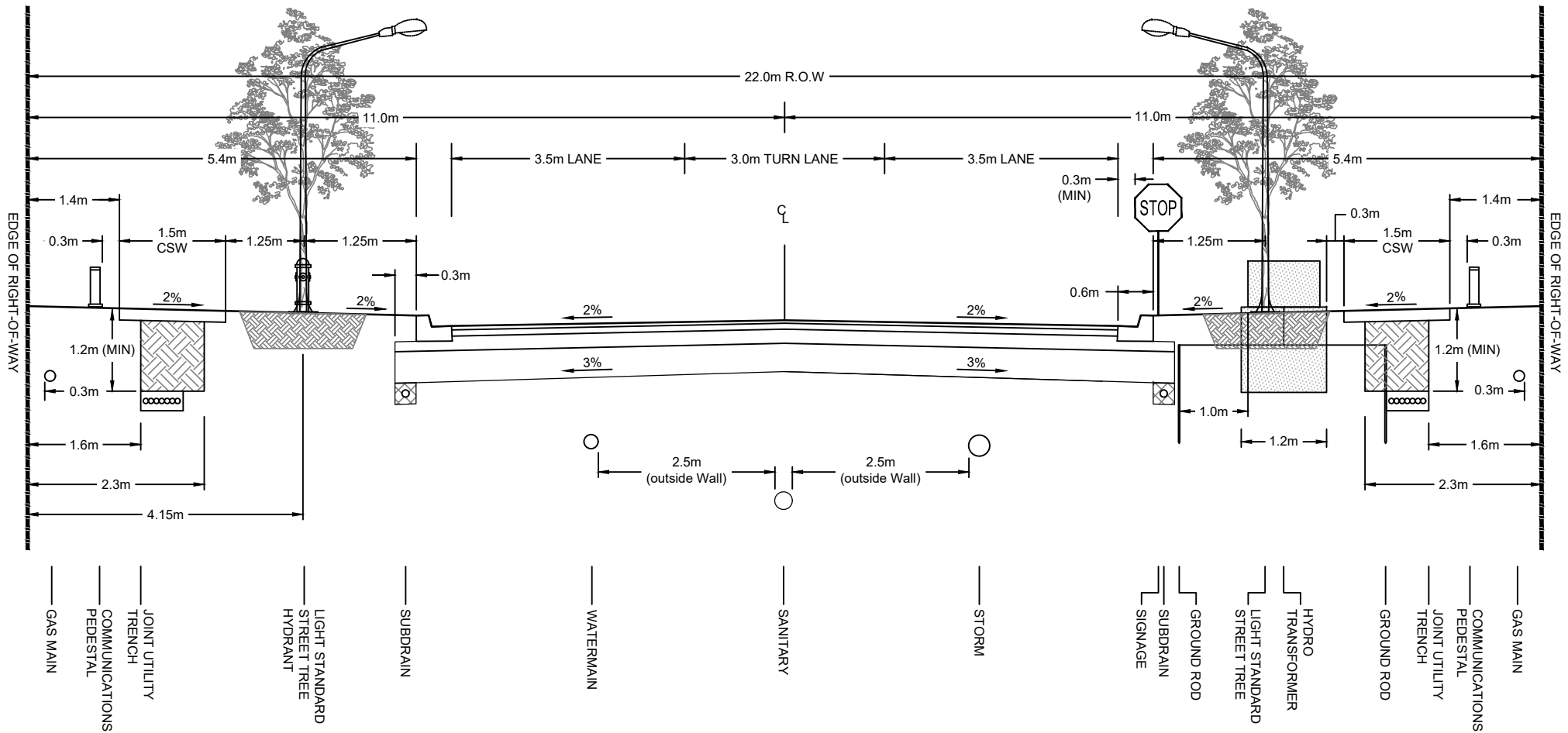

NOTES:

1. WATER DISTRIBUTION, WASTEWATER AND STORMWATER SYSTEMS TO BE DESIGNED IN ACCORDANCE WITH APPLICABLE TOWN OF TILLSONBURG DEVELOPMENT GUIDELINES & DESIGN CRITERIA, OXFORD COUNTY DESIGN GUIDELINES & SPECIFICATIONS, AND ONTARIO PROVINCIAL STANDARDS (OPSS/OPSD).
2. REFER TO SECTION 08 - STREET LIGHTING, TOWN OF TILLSONBURG DEVELOPMENT GUIDELINES & DESIGN CRITERIA AND ASSOCIATED TSD'S FOR LIGHT STANDARD AND POLE BASE LOCATION AND DEPTH.
3. REFER TO SECTION 07 - ROADS, TOWN OF TILLSONBURG DEVELOPMENT GUIDELINES & DESIGN CRITERIA FOR PAVEMENT DESIGN SPECIFICATIONS.
4. REFER TO SECTION 14 - PARKS AND STREETSCLAPING, TOWN OF TILLSONBURG DEVELOPMENT GUIDELINES & DESIGN CRITERIA FOR STREET TREE SPECIFICATIONS. LOCATIONS WILL REQUIRE APPROVAL BY THE TOWN OF TILLSONBURG ENGINEERING DEPARTMENT.
5. WIDENING MAY BE REQUIRED AT INTERSECTIONS TO ACCOMMODATE REQUIRED TURN-LANES.



STANDARD DETAIL

22.0m COLLECTOR ROAD
ALLOWANCE (TURN LANE)
10.0m ASPHALT

APPROVED

MANAGER OF ENGINEERING DATE

DIRECTOR OF OPERATIONS DATE

REVISION No. DATE: FEB 2022

SCALE: N.T.S.

TSD-703

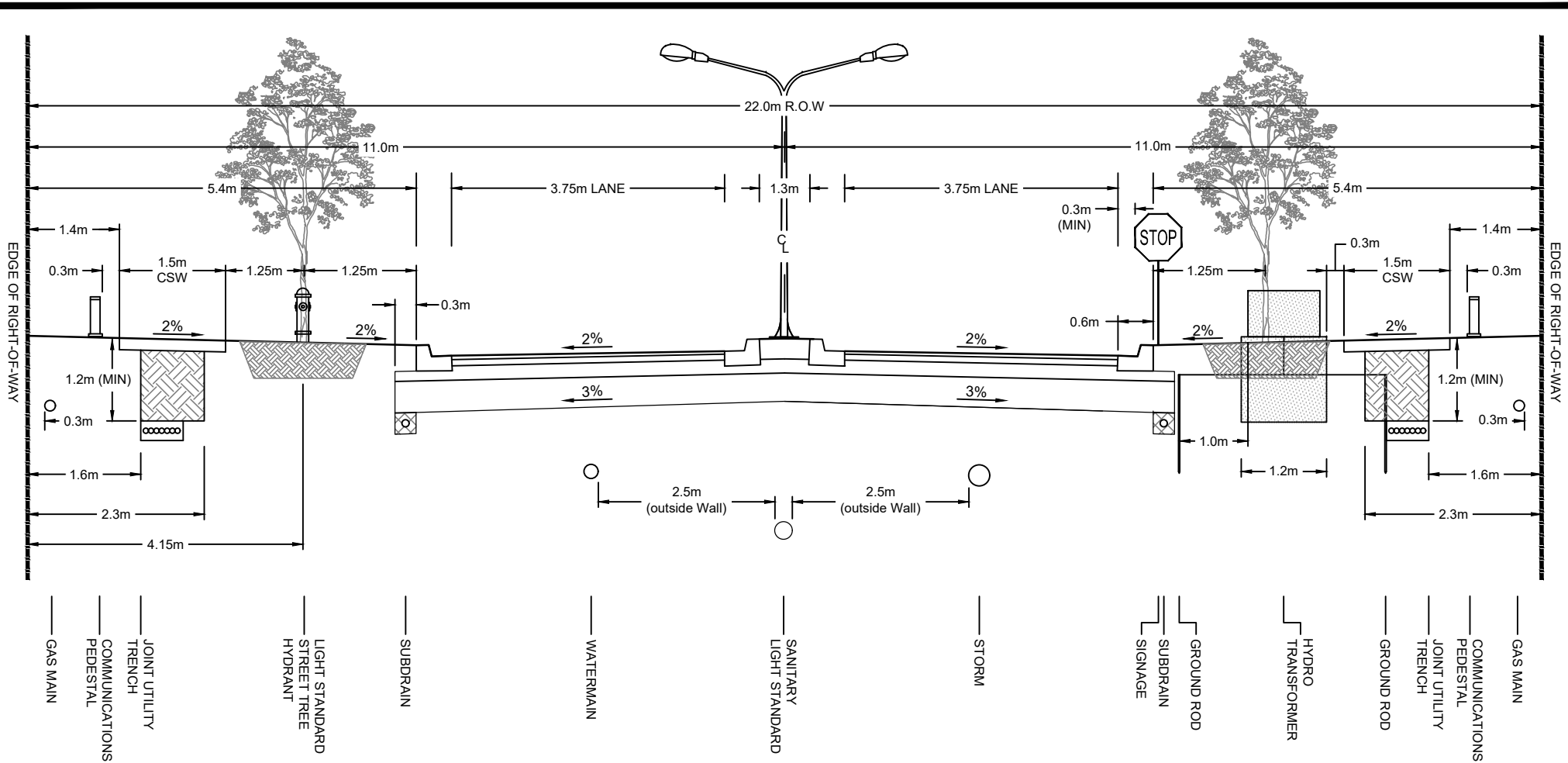

NOTES:

1. WATER DISTRIBUTION, WASTEWATER AND STORMWATER SYSTEMS TO BE DESIGNED IN ACCORDANCE WITH APPLICABLE TOWN OF TILLSONBURG DEVELOPMENT GUIDELINES & DESIGN CRITERIA, OXFORD COUNTY DESIGN GUIDELINES & SPECIFICATIONS, AND ONTARIO PROVINCIAL STANDARDS (OPSS/OPSD).
2. REFER TO SECTION 08 - STREET LIGHTING, TOWN OF TILLSONBURG DEVELOPMENT GUIDELINES & DESIGN CRITERIA AND ASSOCIATED TSD'S FOR LIGHT STANDARD AND POLE BASE LOCATION AND DEPTH.
3. REFER TO SECTION 07 - ROADS, TOWN OF TILLSONBURG DEVELOPMENT GUIDELINES & DESIGN CRITERIA FOR PAVEMENT DESIGN SPECIFICATIONS.
4. REFER TO SECTION 14 - PARKS AND STREETSCAPING, TOWN OF TILLSONBURG DEVELOPMENT GUIDELINES & DESIGN CRITERIA FOR STREET TREE SPECIFICATIONS. LOCATIONS WILL REQUIRE APPROVAL BY THE TOWN OF TILLSONBURG ENGINEERING DEPARTMENT.



22.0m COLLECTOR ROAD
ALLOWANCE (MEDIAN)
10.0m ASPHALT

APPROVED

MANAGER OF ENGINEERING DATE
DIRECTOR OF OPERATIONS DATE

REVISION No. DATE: FEB 2022
SCALE: N.T.S.

TSD-704

STANDARD DETAIL

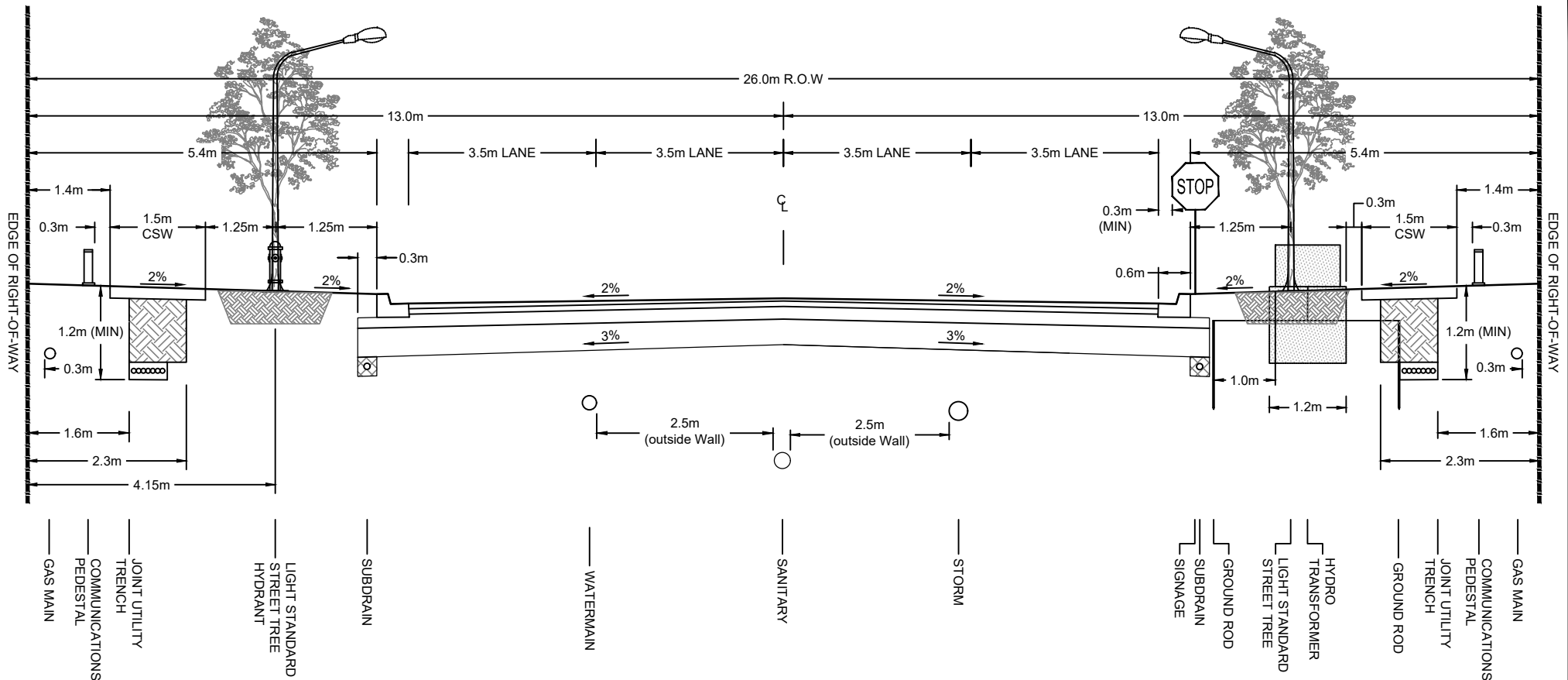

NOTES:

1. WATER DISTRIBUTION, WASTEWATER AND STORMWATER SYSTEMS TO BE DESIGNED IN ACCORDANCE WITH APPLICABLE TOWN OF TILLSONBURG DEVELOPMENT GUIDELINES & DESIGN CRITERIA, OXFORD COUNTY DESIGN GUIDELINES & SPECIFICATIONS, AND ONTARIO PROVINCIAL STANDARDS (OPSS/OPSD).
2. REFER TO SECTION 08 - STREET LIGHTING, TOWN OF TILLSONBURG DEVELOPMENT GUIDELINES & DESIGN CRITERIA AND ASSOCIATED TSD'S FOR LIGHT STANDARD AND POLE BASE LOCATION AND DEPTH.
3. REFER TO SECTION 07 - ROADS, TOWN OF TILLSONBURG DEVELOPMENT GUIDELINES & DESIGN CRITERIA FOR PAVEMENT DESIGN SPECIFICATIONS.
4. REFER TO SECTION 14 - PARKS AND STREETSCAPING, TOWN OF TILLSONBURG DEVELOPMENT GUIDELINES & DESIGN CRITERIA FOR STREET TREE SPECIFICATIONS. LOCATIONS WILL REQUIRE APPROVAL BY THE TOWN OF TILLSONBURG ENGINEERING DEPARTMENT.



STANDARD DETAIL

26.0m ARTERIAL ROAD
ALLOWANCE
14.0m ASPHALT

APPROVED

MANAGER OF ENGINEERING DATE
DIRECTOR OF OPERATIONS DATE

REVISION No. DATE: FEB 2022
SCALE: N.T.S.

TSD-705

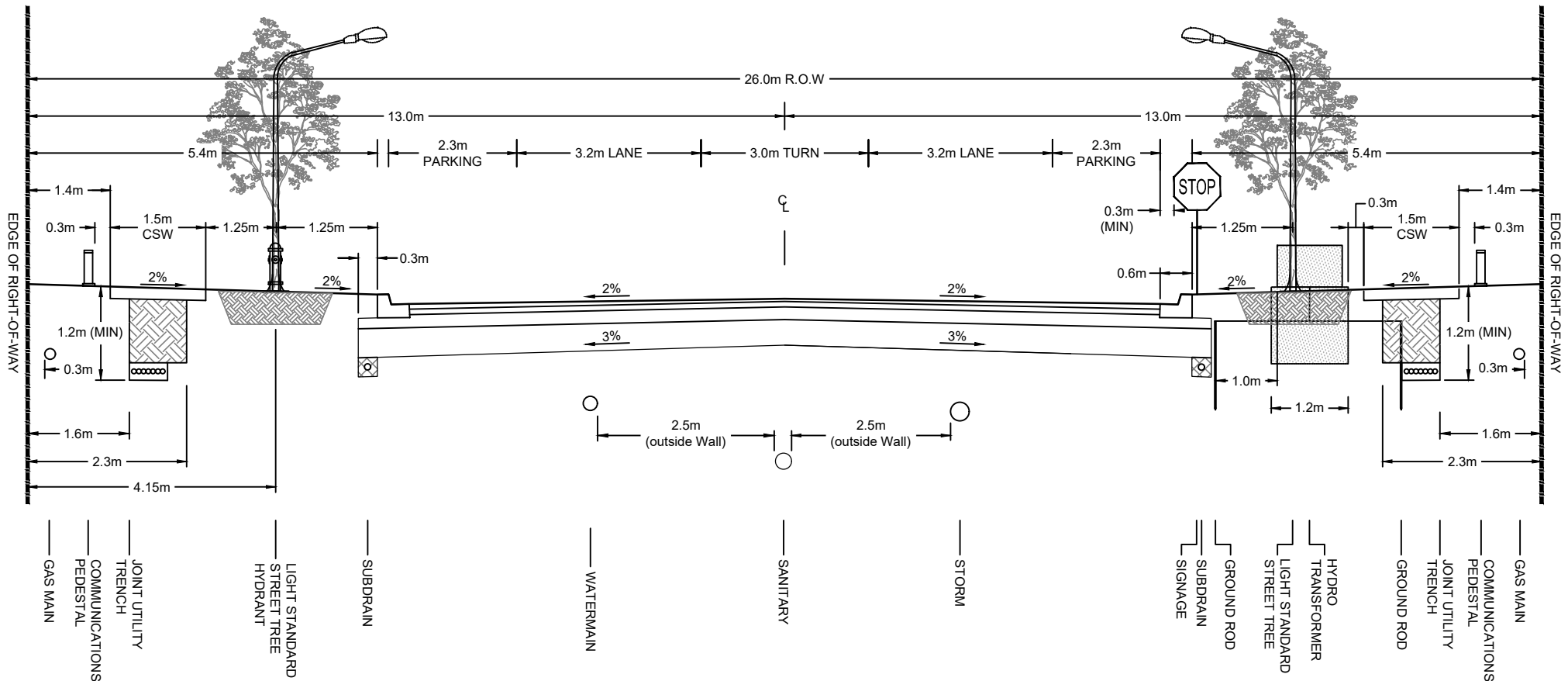

NOTES:

1. WATER DISTRIBUTION, WASTEWATER AND STORMWATER SYSTEMS TO BE DESIGNED IN ACCORDANCE WITH APPLICABLE TOWN OF TILLSONBURG DEVELOPMENT GUIDELINES & DESIGN CRITERIA, OXFORD COUNTY DESIGN GUIDELINES & SPECIFICATIONS, AND ONTARIO PROVINCIAL STANDARDS (OPSS/OPSD).
2. REFER TO SECTION 08 - STREET LIGHTING, TOWN OF TILLSONBURG DEVELOPMENT GUIDELINES & DESIGN CRITERIA AND ASSOCIATED TSD'S FOR LIGHT STANDARD AND POLE BASE LOCATION AND DEPTH.
3. REFER TO SECTION 07 - ROADS, TOWN OF TILLSONBURG DEVELOPMENT GUIDELINES & DESIGN CRITERIA FOR PAVEMENT DESIGN SPECIFICATIONS.
4. REFER TO SECTION 14 - PARKS AND STREETSCLAPING, TOWN OF TILLSONBURG DEVELOPMENT GUIDELINES & DESIGN CRITERIA FOR STREET TREE SPECIFICATIONS. LOCATIONS WILL REQUIRE APPROVAL BY THE TOWN OF TILLSONBURG ENGINEERING DEPARTMENT.
5. WIDENING MAY BE REQUIRED AT INTERSECTIONS TO ACCOMMODATE REQUIRED TURN-LANES.



STANDARD DETAIL

26.0m ARTERIAL ROAD
ALLOWANCE (PARKING)
14.0m ASPHALT

APPROVED

MANAGER OF ENGINEERING DATE

DIRECTOR OF OPERATIONS DATE

REVISION No. DATE: FEB 2022

SCALE: N.T.S.

TSD-706

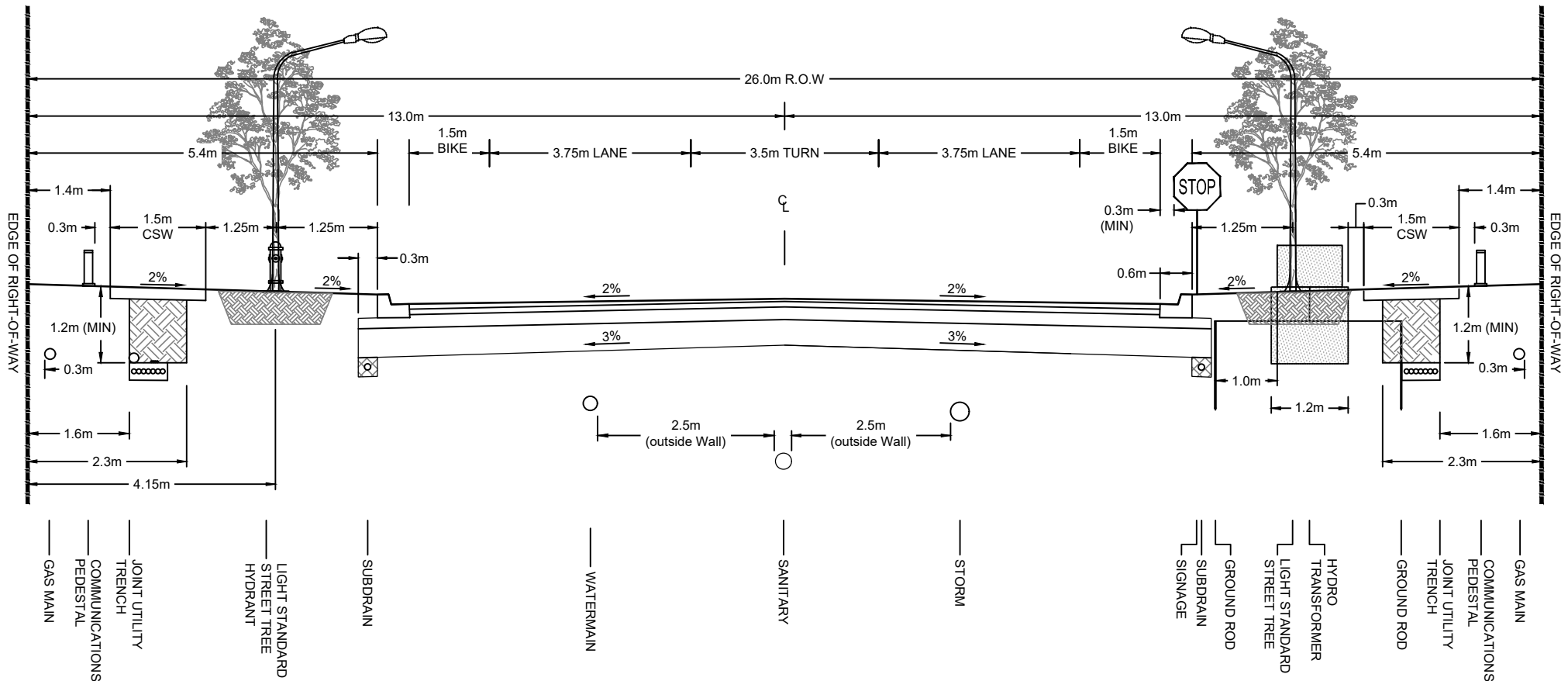

NOTES:

1. WATER DISTRIBUTION, WASTEWATER AND STORMWATER SYSTEMS TO BE DESIGNED IN ACCORDANCE WITH APPLICABLE TOWN OF TILLSONBURG DEVELOPMENT GUIDELINES & DESIGN CRITERIA, OXFORD COUNTY DESIGN GUIDELINES & SPECIFICATIONS, AND ONTARIO PROVINCIAL STANDARDS (OPSS/OPSD).
2. REFER TO SECTION 08 - STREET LIGHTING, TOWN OF TILLSONBURG DEVELOPMENT GUIDELINES & DESIGN CRITERIA AND ASSOCIATED TSD'S FOR LIGHT STANDARD AND POLE BASE LOCATION AND DEPTH.
3. REFER TO SECTION 07 - ROADS, TOWN OF TILLSONBURG DEVELOPMENT GUIDELINES & DESIGN CRITERIA FOR PAVEMENT DESIGN SPECIFICATIONS.
4. REFER TO SECTION 14 - PARKS AND STREETSCLAPING, TOWN OF TILLSONBURG DEVELOPMENT GUIDELINES & DESIGN CRITERIA FOR STREET TREE SPECIFICATIONS. LOCATIONS WILL REQUIRE APPROVAL BY THE TOWN OF TILLSONBURG ENGINEERING DEPARTMENT.
5. WIDENING MAY BE REQUIRED AT INTERSECTIONS TO ACCOMMODATE REQUIRED TURN-LANES.



STANDARD DETAIL

26.0m ARTERIAL ROAD
ALLOWANCE (BIKE LANES)
14.0m ASPHALT

APPROVED

MANAGER OF ENGINEERING DATE

DIRECTOR OF OPERATIONS DATE

REVISION No. DATE: FEB 2022

SCALE: N.T.S.

TSD-707

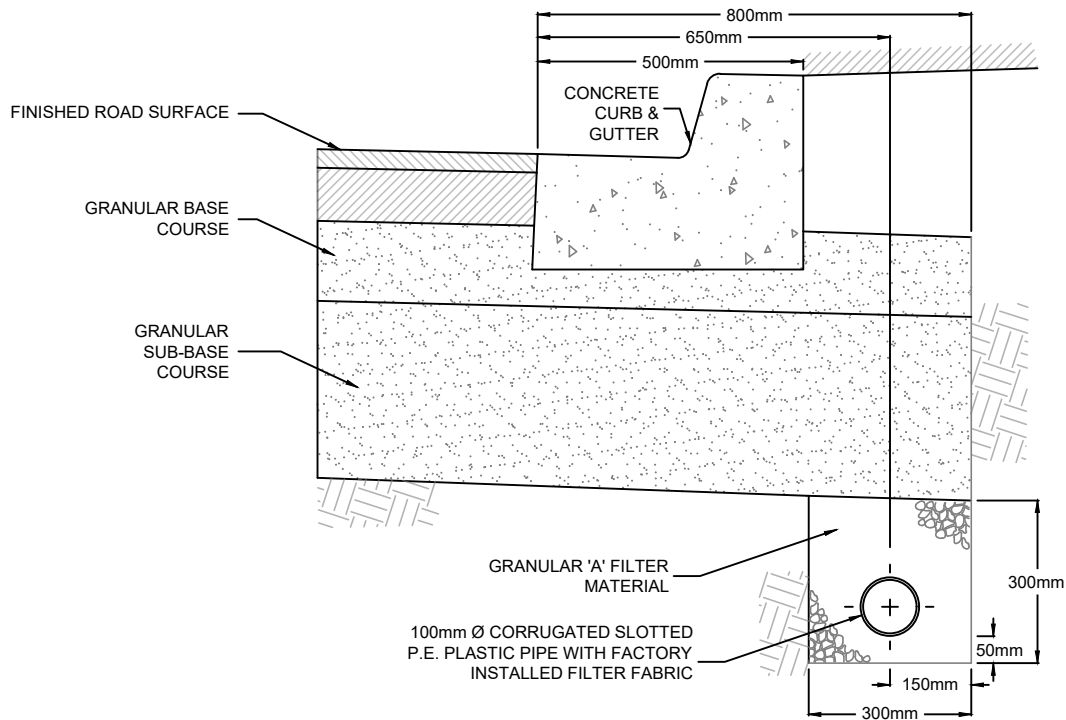

TYPE 'A' - TYPICAL

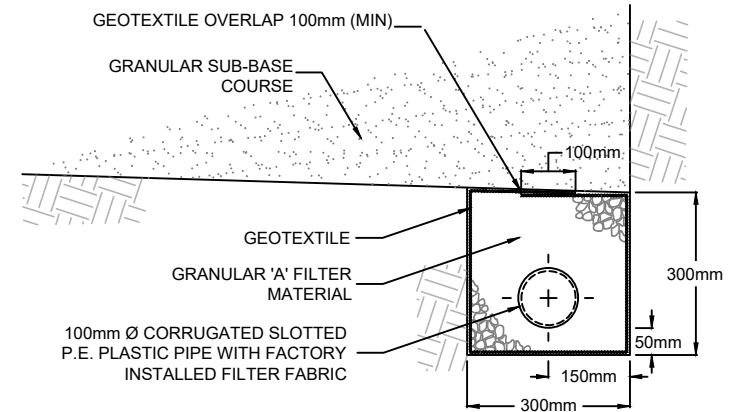

TYPE 'B' - HIGH GROUND WATER

NOTES:

1. ALL CONNECTIONS TO BE MADE ON THE UPSTREAM SIDE OF ALL CATCH BASINS. MORTARED INSIDE AND OUTSIDE.
2. SUBDRAINS TO BE PLUGGED AT THE HIGH END WITH A MANUFACTURED PLUG.
3. ALL DIMENSIONS ARE IN MILLIMETRES UNLESS OTHERWISE SHOWN.
4. FOR SELECTION OF TYPE 'A' AND TYPE 'B' SUBDRAINS REFER TO TOWN OF TILLSONBURG DEVELOPMENT GUIDELINES AND DESIGN CRITERIA.
5. TYPE 'B' : THE SUBDRAIN TRENCH SHALL BE LINED WITH CLASS II, NON-WOVEN GEOTEXTILE, WITH AN F.D.S. OF 75-150 μ m AND A MINIMUM THICKNESS OF 1 mm.



STANDARD DETAIL

**TYPICAL 100mm SUBDRAIN
DETAIL**

APPROVED

MANAGER OF ENGINEERING DATE
DIRECTOR OF OPERATIONS DATE

REVISION No. DATE: MARCH 2020
SCALE: N.T.S.

TSD-710

WIDTH SHALL BE IN ACCORDANCE WITH THE TOWN OF TILLSONBURG DEVELOPMENT GUIDELINES AND DESIGN CRITERIA

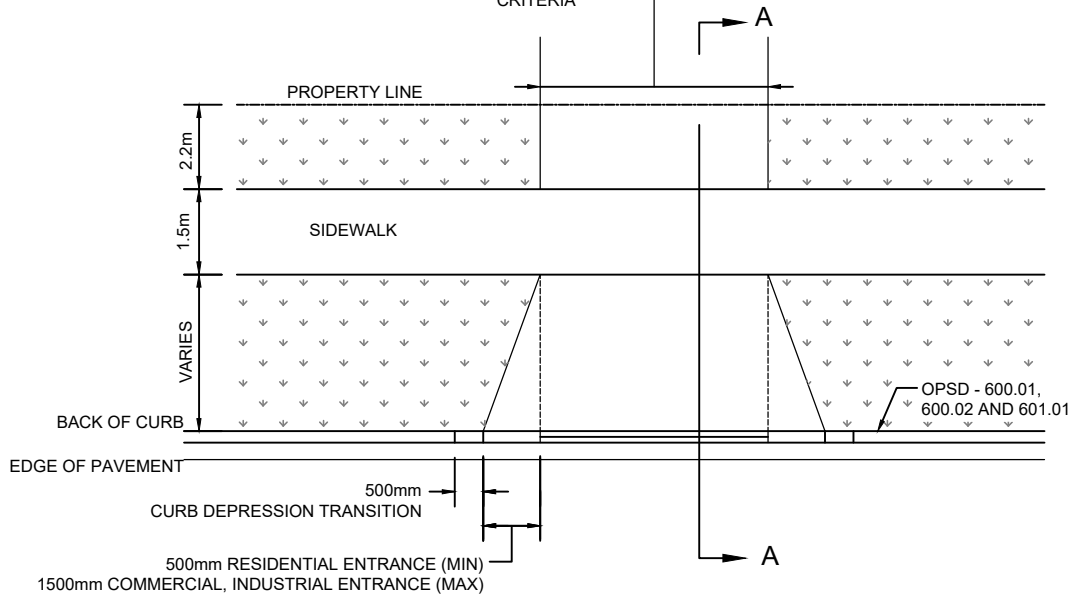

PLAN

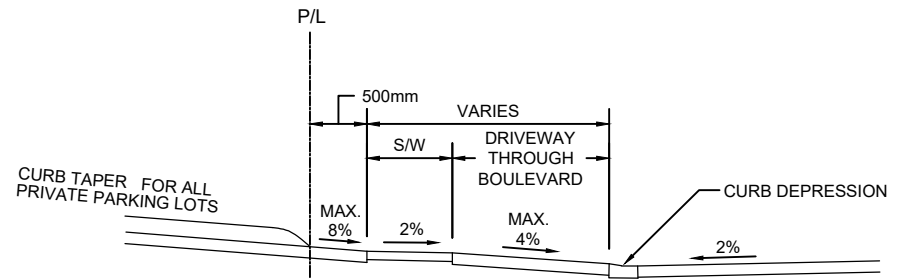

SECTION A-A

NOTES:

1. CROSSFALL OF SIDEWALK 2.0% UNLESS OTHERWISE APPROVED BY TOWN OF TILLSONBURG ENGINEERING DEPARTMENT.
2. ALL DIMENSIONS ARE IN MILLIMETRES UNLESS OTHERWISE SHOWN.
3. REVERSE GRADES WILL NOT BE ACCEPTED.



STANDARD DETAIL

DRIVEWAY AND ENTRANCE DETAIL

APPROVED

MANAGER OF ENGINEERING DATE
DIRECTOR OF OPERATIONS DATE

REVISION No. DATE: DEC 2021
SCALE: N.T.S.

TSD-711

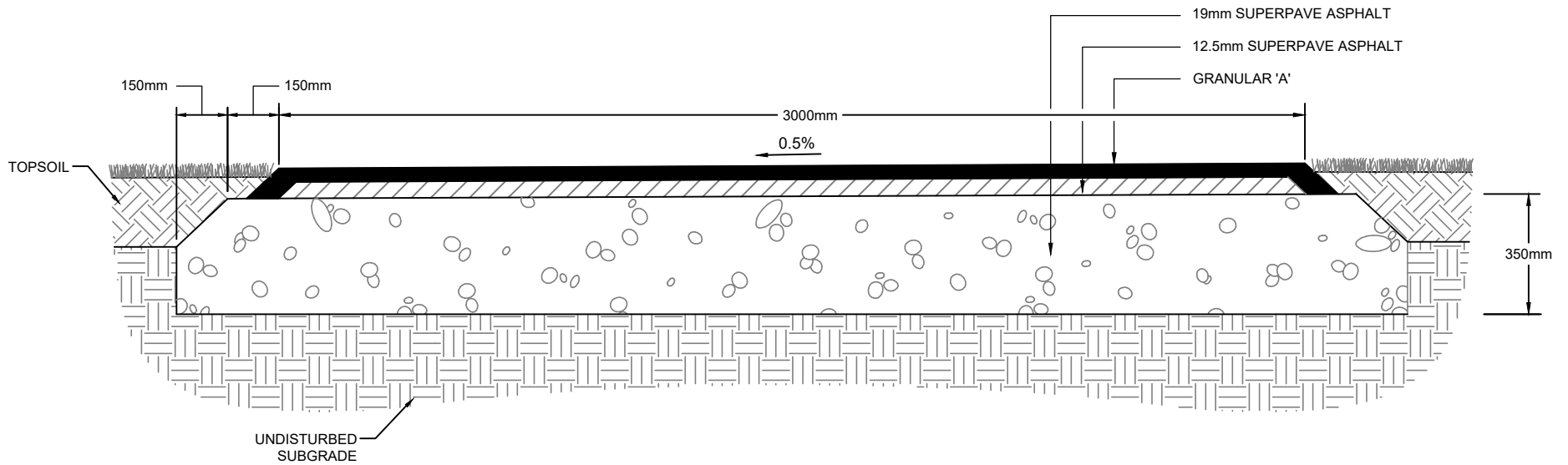

NOTES:

1. ASPHALT SHALL BE PLACED AND SPREAD USING A MECHANICAL PAVER.
2. ASPHALT LAYERS (AFTER ROLLING) TO BE COMPACTED TO A MINIMUM 97% S.P.M.D.D.
3. IN THE EVENT OF UNSUITABLE SUB-GRADE MATERIAL, BASE IS TO BE OVER-EXCAVATED AND BACKFILLED WITH GRANULAR 'B' COMPACTED TO 98% S.P.M.D.D.
4. ALL BACKFILL TO BE COMPACTED IN LIFTS OF 100mm.
5. ENSURE POSITIVE DRAINAGE.
6. TAMP ALL EDGES TO A FIRM 45 DEGREE BEVEL.
7. ALL DIMENSIONS ARE IN MILLIMETRES UNLESS OTHERWISE SHOWN.



STANDARD DETAIL

BOULEVARD PATHWAY

APPROVED

MANAGER OF ENGINEERING DATE
 DIRECTOR OF OPERATIONS DATE

REVISION No. DATE: DEC 2021
 SCALE: N.T.S.

TSD-712

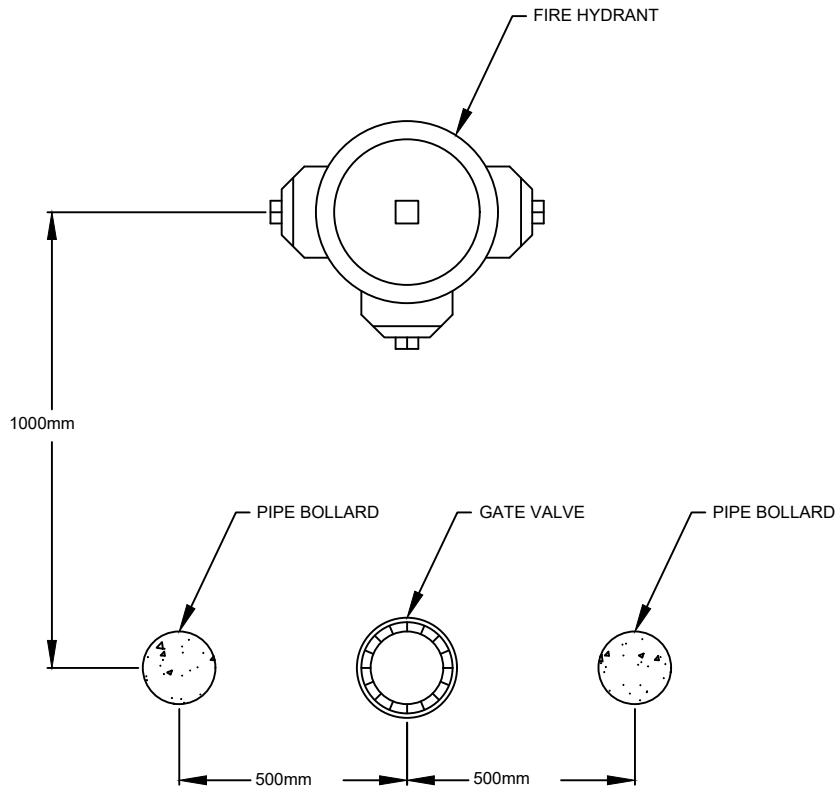

NOTES:

1. DIMENSION MAY BE REDUCED TO SUIT AVAILABLE SPACE IN BOULEVARD AREA (DIMENSION - PROVIDED SPACE IS AVAILABLE).
2. ALL DIMENSIONS ARE IN MILLIMETRES UNLESS NOTED OTHERWISE.
3. REQUIRED NUMBER OF BOLLARDS AND LOCATIONS MAY VARY WITH DIRECTION OF HAZARD(S).

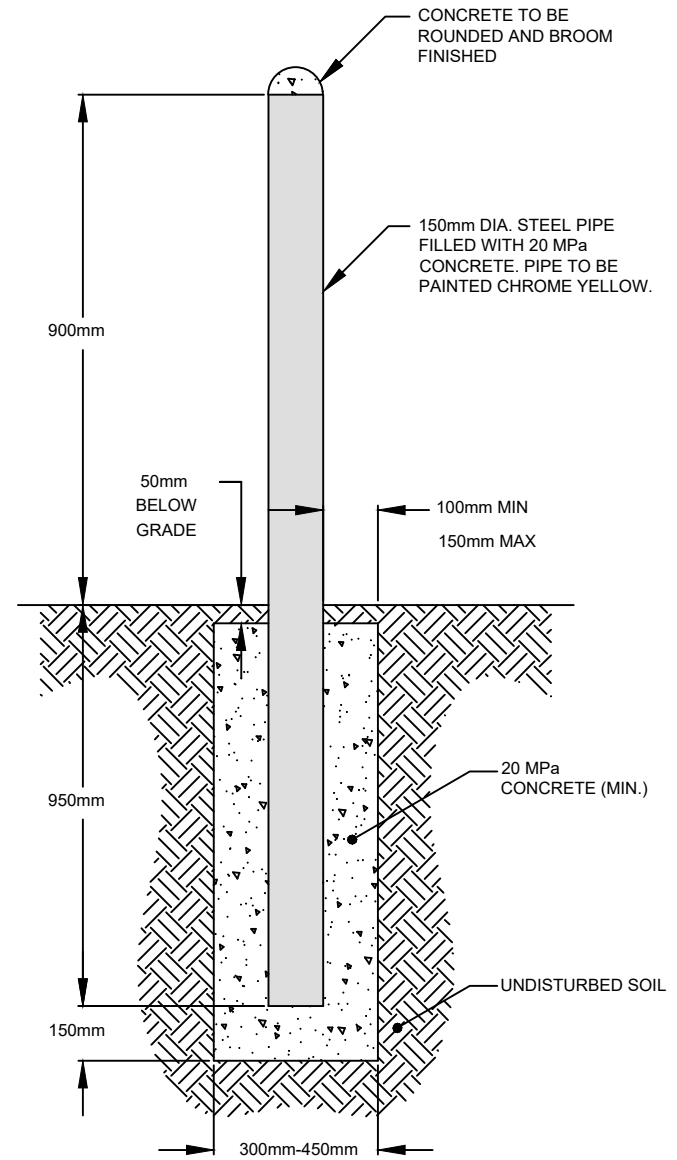

STANDARD DETAIL

PIPE BOLLARD

APPROVED

MANAGER OF ENGINEERING DATE
 DIRECTOR OF OPERATIONS DATE

REVISION No. DATE: MARCH 2020
 SCALE: N.T.S.

TSD-713

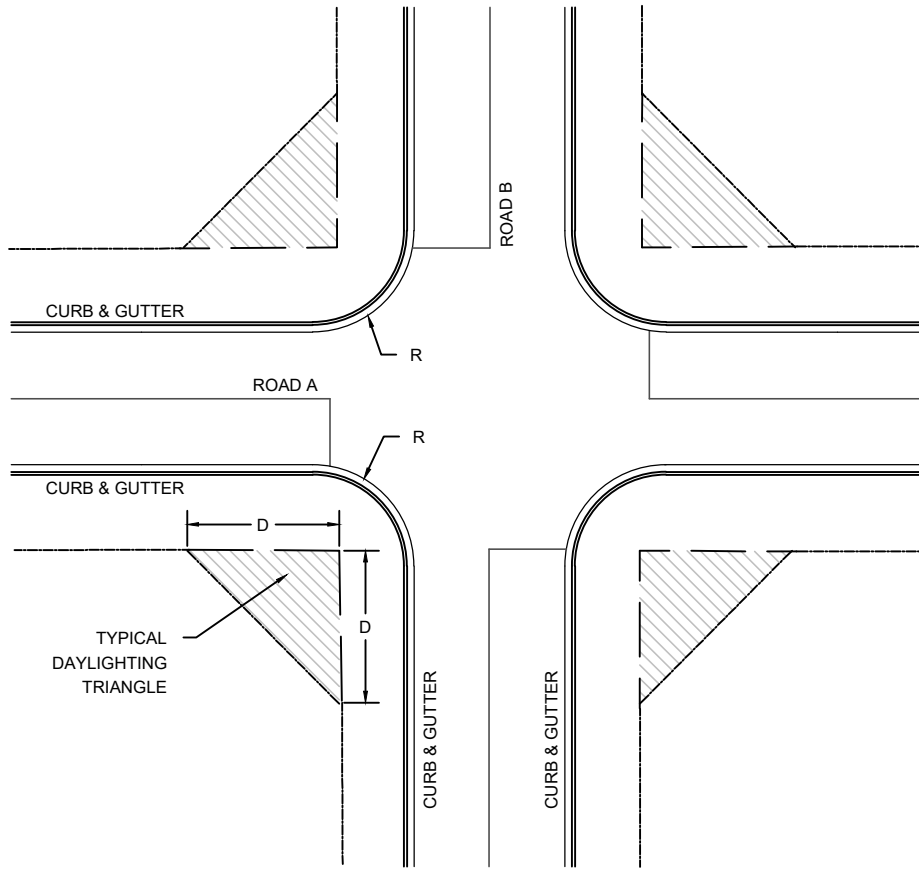

INTERSECTION TYPE ROAD "A" TO ROAD "B"	CURB RADIUS R (m)	D (m)
LOCAL TO LOCAL	7.5	3X3
LOCAL TO COLLECTOR	9.0	5X7
LOCAL TO ARTERIAL	9.0	5X10
COLLECTOR TO COLLECTOR	12.0	7X7
COLLECTOR TO ARTERIAL	12.0	7X10
ARTERIAL TO ARTERIAL	15.0	10X10
INDUSTRIAL TO ANY OTHER STREET	18.0	12X12

NOTES:

1. CURB RADII IN TABLE ARE FROM 90-DEGREE INTERSECTIONS. OTHER INTERSECTION ANGLES WILL REQUIRE DIFFERENT RADII TO ACCOMMODATE THE SAME DESIGN VEHICLE.
2. DESIGN CRITERIA TO CONFORM WITH MTO DOCUMENT GEOMETRIC DESIGN STANDARDS FOR CANADIAN ROADS (METRIC) AND TOWN OF TILLSONBURG DEVELOPMENT GUIDELINES & DESIGN CRITERIA.
3. ALL DIMENSIONS ARE IN METRES UNLESS OTHERWISE SHOWN.



STANDARD DETAIL

TYPICAL DAYLIGHTING REQUIREMENTS

APPROVED

MANAGER OF ENGINEERING DATE
 DIRECTOR OF OPERATIONS DATE

REVISION No. DATE: MARCH 2020
 SCALE: N.T.S.

TSD-720

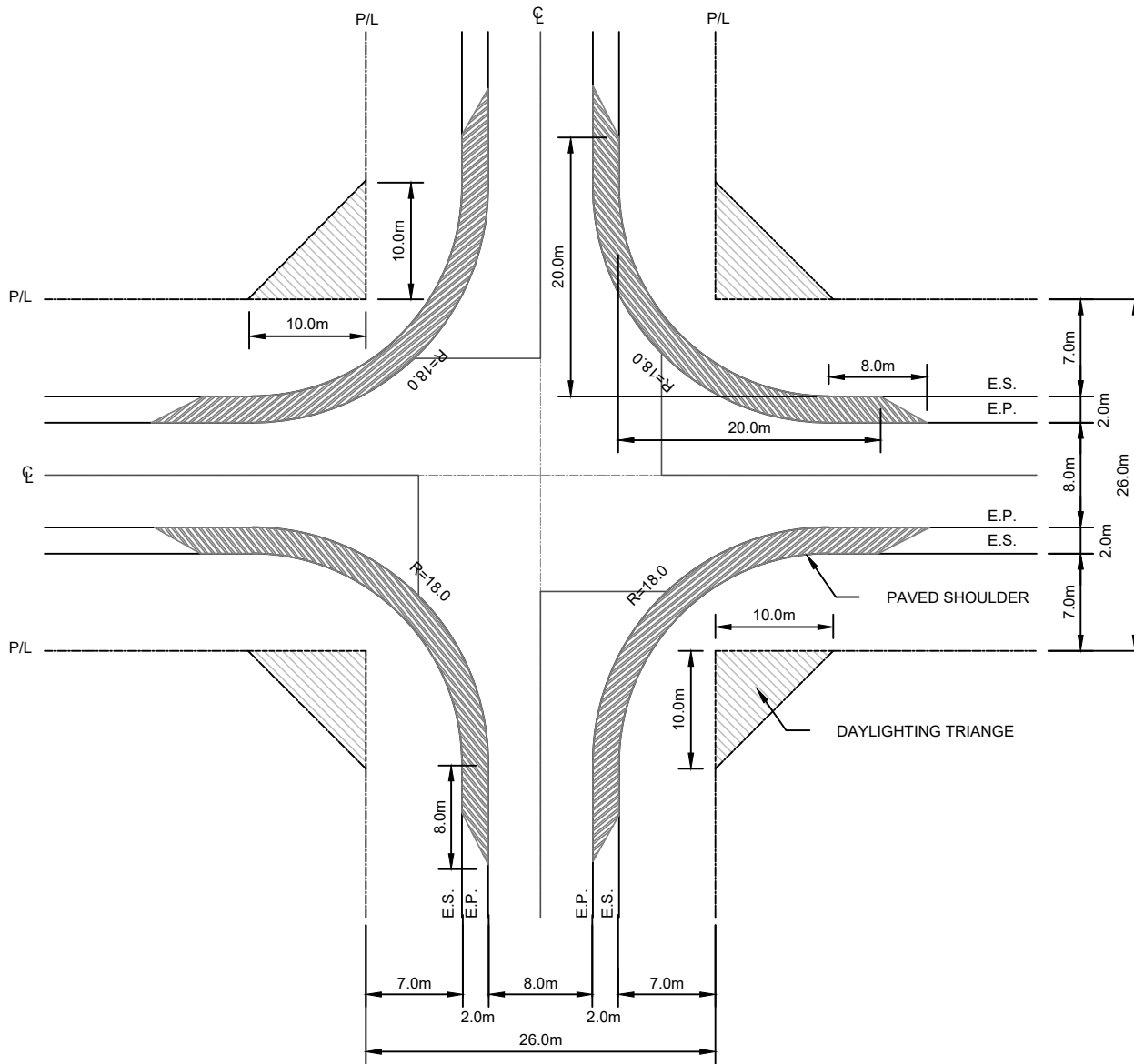

NOTES:

1. PAVED SHOULDER TO HAVE THE SAME DEPTH OF ASPHALT AS THE ROADWAY.
2. ALL DIMENSIONS ARE IN METRES UNLESS OTHERWISE SHOWN.
3. ASPHALT SHOULDER TO EXTEND 8.0m BEYOND THE CURVE TERMINATION POINT.



STANDARD DETAIL

**TYPICAL INTERSECTION
SEMI-URBAN
18m RADIUS 26m R.O.W.**

APPROVED

MANAGER OF ENGINEERING DATE
DIRECTOR OF OPERATIONS DATE

REVISION No. DATE: MARCH 2020
SCALE: N.T.S.

TSD-721

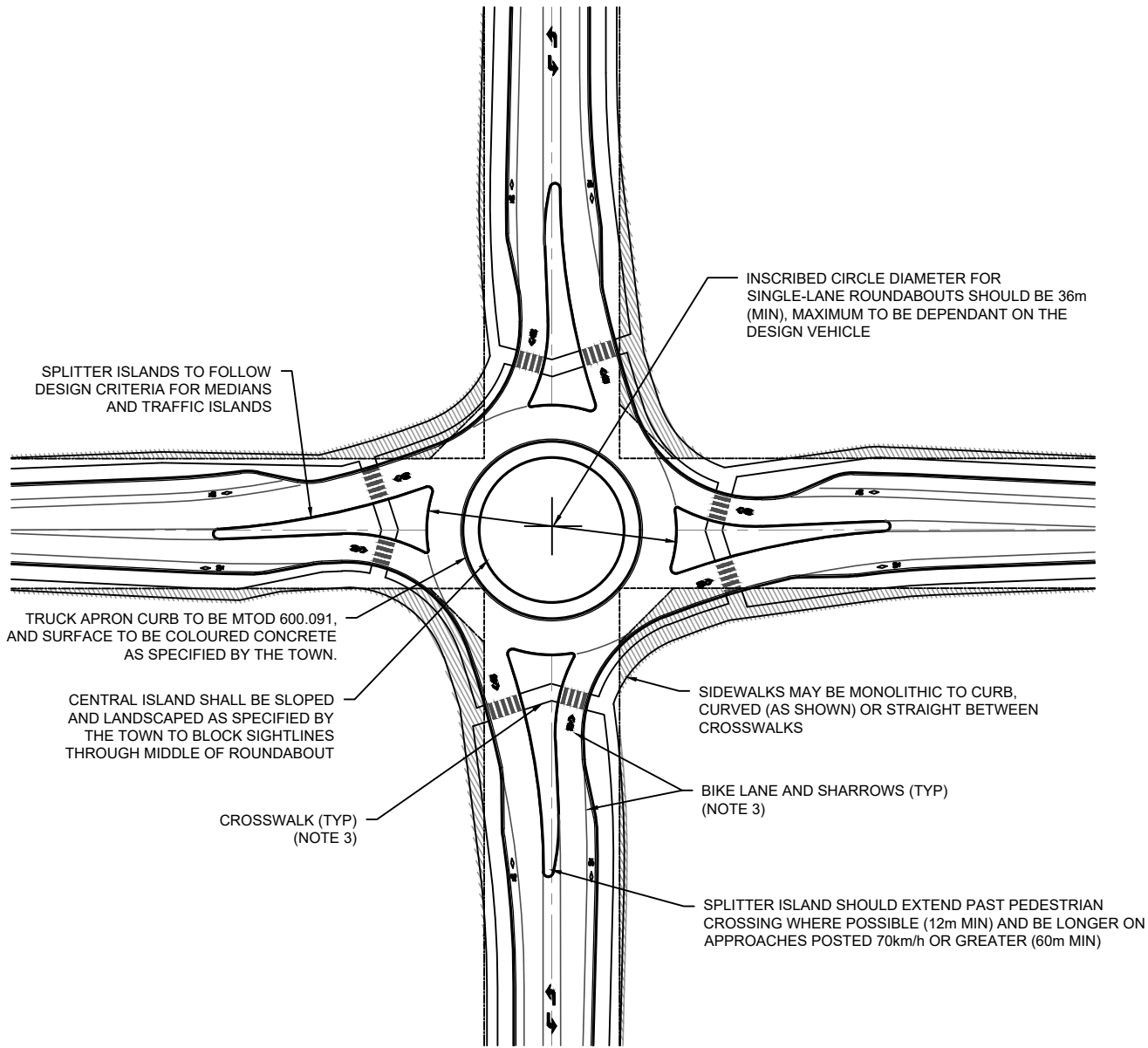

NOTES:

1. LAYOUT IS TYPICAL AND SHOULD BE REFINED THROUGH FURTHER DESIGN
2. ROUNDABOUT SIGNAGE AND MARKINGS TO FOLLOW THE MUTCD FOR CANADA
3. REFER TO TSD-723 FOR BIKE LANE, SHARROWS AND CROSSWALK TYPICALS.



STANDARD DETAIL

ROUNDABOUT SINGLE-LANE

APPROVED

.....
MANAGER OF ENGINEERING DATE

.....
DIRECTOR OF OPERATIONS DATE

REVISION No. DATE: MARCH 2020

SCALE: N.T.S.

TSD-722

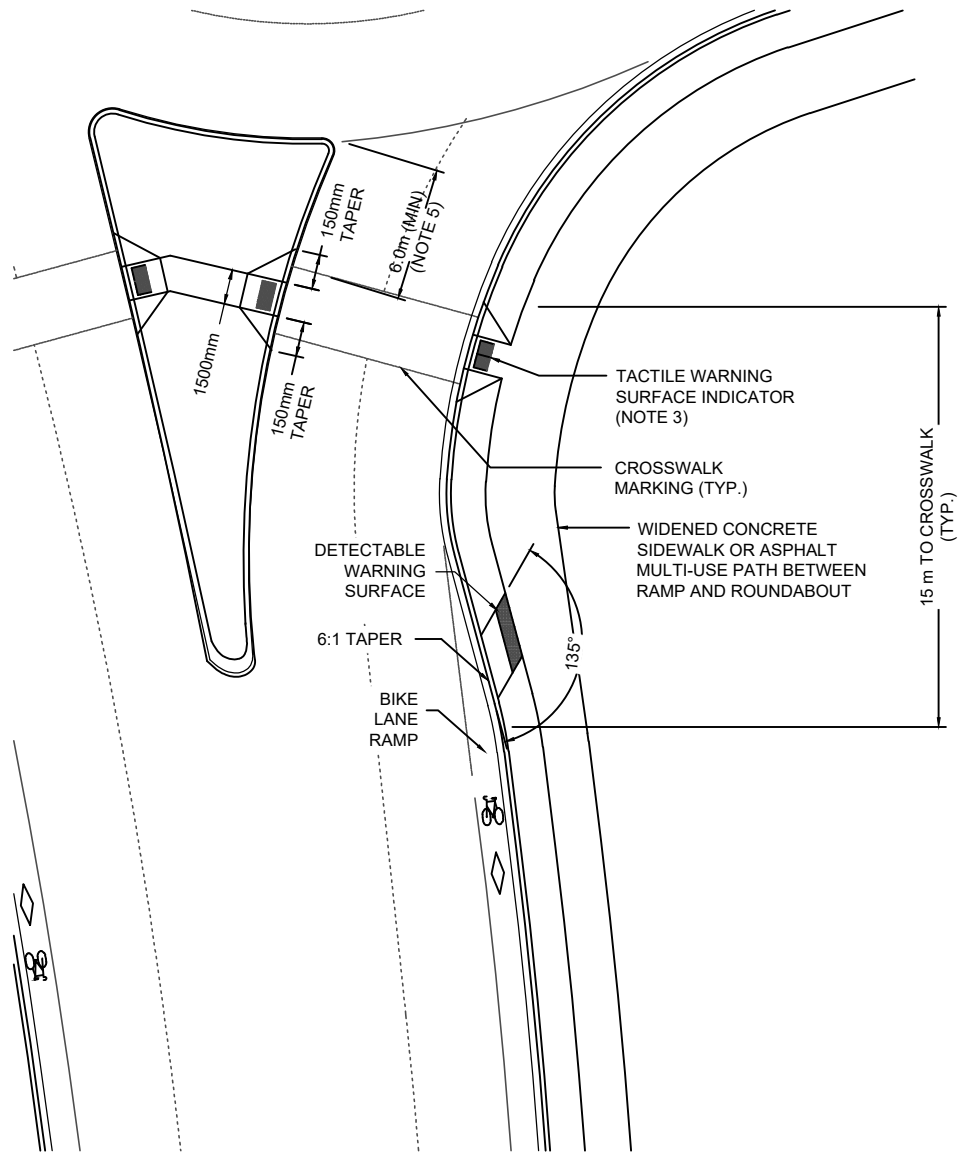

NOTES:

1. LAYOUT IS TYPICAL AND SHOULD BE REFINED THROUGH FURTHER DESIGN
2. FOR ADDITIONAL SIDEWALK RAMPING DETAILS REFER TO OPSDs 310.030, 310.031, 310.033.
3. FOR TACTILE WARNING SURFACE INDICATOR DETAILS, REFER TO OPSD 310.039
4. FOR CROSSWALK MARKINGS AND SIGNAGE REFER TO OTM BOOK 15
5. 12m RECOMMENDED WITH LEVEL 2 PEDESTRIAN CROSSOVER
6. FOR BIKE FACILITY MARKINGS AND SIGNAGE REFER TO OTM BOOK 18
7. ALL DIMENSIONS IN MILLIMETRES UNLESS OTHERWISE NOTED.



STANDARD DETAIL

SIDEWALK RAMPS, BIKE LANES, CROSSWALKS AT ROUNDABOUTS

APPROVED

.....
 MANAGER OF ENGINEERING DATE

 DIRECTOR OF OPERATIONS DATE

REVISION No.	DATE: MARCH 2020
	SCALE: N.T.S.

TSD-723

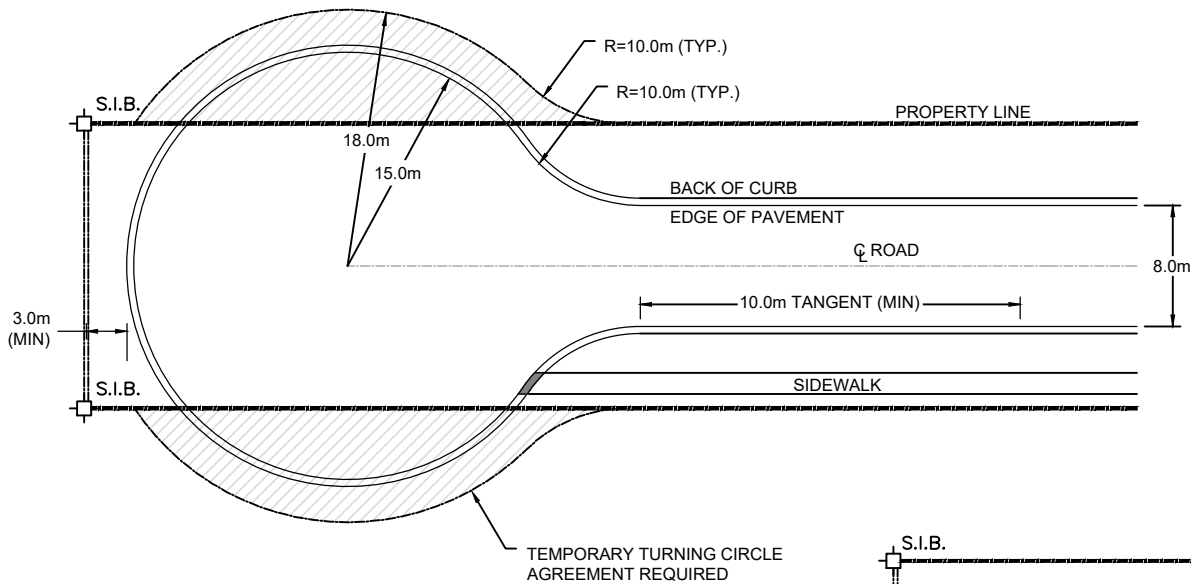

TYPE 'A'

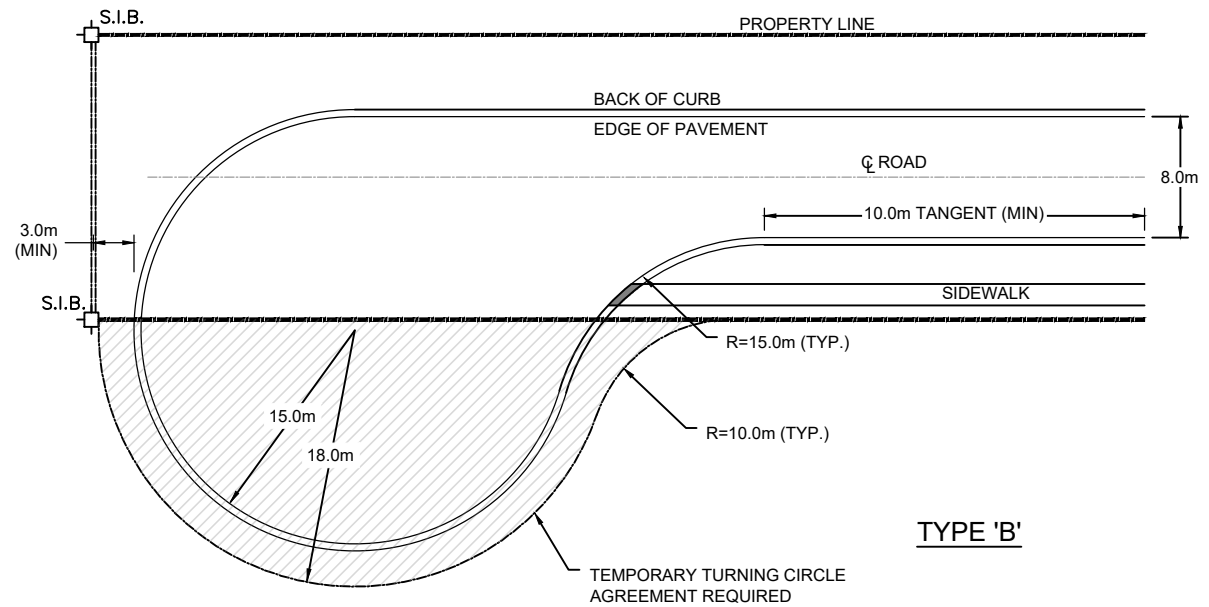

TYPE 'B'

NOTES:

1. ALL DIMENSIONS IN METRES UNLESS OTHERWISE NOTED.



STANDARD DETAIL

TEMPORARY RESIDENTIAL CUL-DE-SAC

APPROVED

MANAGER OF ENGINEERING DATE
DIRECTOR OF OPERATIONS DATE

REVISION No. DATE: MARCH 2020
SCALE: N.T.S.

TSD-730

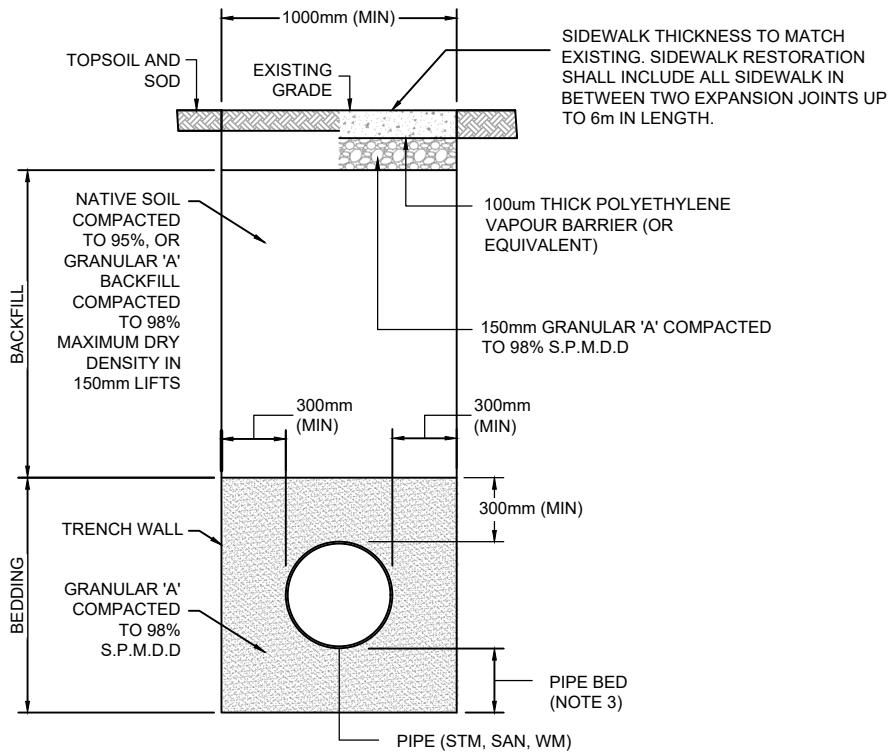

BOULEVARD

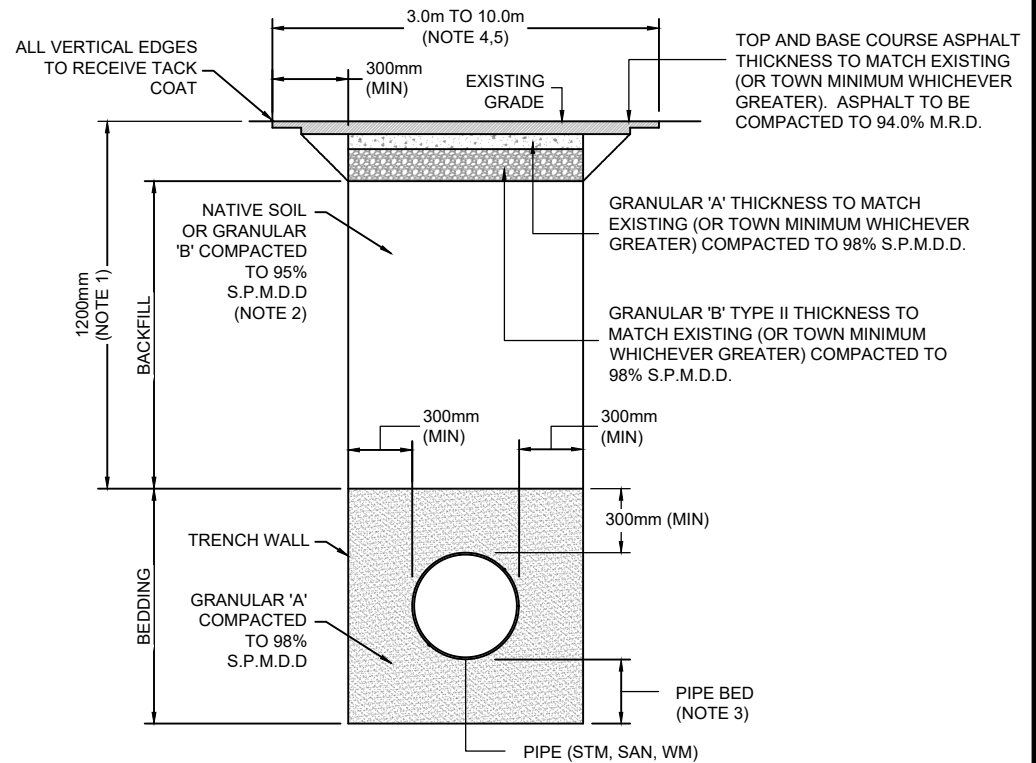

ROADWAY

NOTES:

1. FROST TAPER USED IF DEPTH IS LESS THAN 1200mm
2. UNSHRINKABLE FILL TO BE USED IN INTERSECTIONS AND ON HIGH VOLUME ARTERIAL/COLLECTOR ROADS.
3. REFER TO TOWN OF TILLSONBURG DEVELOPMENT GUIDELINES AND DESIGN CRITERIA FOR APPLICABLE BEDDING REQUIREMENTS FOR LINEAR INFRASTRUCTURE OF FOCUS.
4. 3.0m (MIN) FOR LONGITUDINAL, 10.0m + TRENCH WIDTH (MIN) FOR TRANSVERSE RESTORATION.
5. IF TRENCH TO FACE OF CURB IS LESS THAN 1000mm, FULL DEPTH ASPHALT IS TO BE REMOVED.
6. ALL DIMENSIONS SHOWN IN MILLIMETRES UNLESS OTHERWISE NOTED.



STANDARD DETAIL

TYPICAL TRENCH RESTORATION

APPROVED

MANAGER OF ENGINEERING DATE
 DIRECTOR OF OPERATIONS DATE

REVISION No. DATE: MARCH 2020
 SCALE: N.T.S.

TSD-740

- 1. GRADE AND CROSSFALL ADJUSTMENT OF MAINTENANCE HOLE AND CATCHBASIN FRAMES WILL BE MADE USING PRODUCTS SPECIFICALLY MANUFACTURED FOR THAT PURPOSE.
- 2. ADJUSTMENT UNITS MUST BE CERTIFIED TO MEET ALL PERTINENT OPS, CSA, ASTM AND MTO-DSM LISTS, OR OTHER INDUSTRY GUIDELINES FOR MATERIALS, PERFORMANCE AND USE AS APPLICABLE.
- 3. ADJUSTMENT UNITS AND JOINTS WILL BE SEALED AND OR PARGED IN COMPLIANCE WITH MANUFACTURERS SPECIFICATIONS AND GUIDELINES
- 4. MORTAR IS USED FOR LEVELING OF PRECAST UNITS ONLY. THE THICKNESS OF MORTAR WILL BE 10mm TO FILL ALL VOIDS CREATED BY IRREGULARITIES IN THE PRECAST UNITS TO ENSURE AN EVEN SURFACE ONLY.



STANDARD DETAIL

GENERAL NOTES FOR ROADWORKS

APPROVED

.....
MANAGER OF ENGINEERING DATE
.....
DIRECTOR OF OPERATIONS DATE
.....

REVISION No.	DATE: MARCH 2020
	SCALE: N.T.S.

TSD-750